

C P R automotive

Übermass – Vorkammern









Tel. 0800 751 9 751
Fax 07742 2917
E-Mail info@cpr-automotive.de

CPR
Rechsteiner

CPR (Deutschland) Auslieferung
Industriestrasse 4
D-79801 Hohentengen
www.cpr-automotive.de

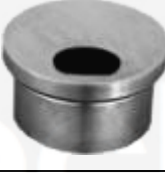





C P R

Übermass-Vorkammern

Modell	Abbildung	Motor Code	Hubraum cm ³	Anzahl Zylinder	CPR Art. Nr.	D ∅ mm	d ∅ mm	H mm	Einspritz Öffnung mm	Typ
Alfa Romeo										
2000TD, 164D 2400TD, 164TD 2500TD		VM80A VM81A VM84A	2400	4	095-0205G	35,60	30,40	4,8	12	1
					095-0205H	36,00	30,40	5,0		
Audi										
80D 80TD 90D/TD		GR ME/MF/ SB	1600	4	095-0803C	30,10	25,40	4,3	11,5	1
					095-0803D	30,50	25,40	4,6		
80D/TD 90D/TD		JK/CY JP/JR	1600	4	095-0101A	32,10	27,40	4,3	11,5	1
					095-0101B	32,20	27,40	4,4		
					095-0101C	32,50	27,40	4,6		
80D/TD		1Y AAZ AEY	1900	4	095-0102A	32,10	27,90	4,3	12,5	1
					095-0102B	32,20	27,90	4,4		
					095-0102C	32,50	27,90	4,6		
100D 100Avant		3D AAS	2400	5	095-0101D	32,10	27,90	4,3	11,5	1
					095-0101E	32,20	27,90	4,4		
					095-0101F	32,50	27,90	4,6		
Bertone										
Freeclimber TD		M21D	2400	6	095-0802A	31,00	27,50	4,3	11	1
					095-0802B	31,50	27,50	4,6		
BMW										
324d/td		246D	2400	6	095-0802A	31,00	27,50	4,3	11	1
325td		246T	2500		095-0802B	31,50	27,50	4,6		
524d/td		246D	2400							
525td		246T	2500							
Chrysler										
Voyager		VM D/TD	2400	4	095-0205G	35,60	30,40	4,8	12	1
					095-0205H	36,00	30,40	5,0		









C P R

Übermass-Vorkammern

Modell	Abbildung	Motor Code	Hubraum cm ³	Anzahl Zylinder	CPR Art. Nr.	D ∅ mm	d ∅ mm	H mm	Einspritz Öffnung mm	Typ
Citroen										
BX19 BX19RD BX19TRD ZXD Xantia Evasion Jumpy Jumper Berlingo		XUD9 XUD9A/L XUD9TE	1900	4	095-0104A	32,15	28,10	4,2	11,5	1
					095-0104B	32,65	28,10	4,5		
Xantia XM		XUD11	2100	4	095-0205C	34,10	29,80	4,2	12	1
					095-0205D	34,50	29,80	4,5		
C25		U/25/651	2500	4	095-0203A	36,50	29,80	5,0	12	2
					095-0203B	37,00	29,80	5,3		
Jumper		DJ5T	2500	4	095-0201A	36,70	31,70	4,2	18	1
					095-0201B	37,00	31,70	4,5		
Jumper		DJ5	2500	4	095-0202A	36,70	31,70	4,2	14	1
					095-0202B	37,00	31,70	4,5		
Daewoo										
Lublin		4C90	2400	4	095-0205A	36,10	30,80	4,8	12	1
					095-0205B	36,50	30,80	5,2		
DAF										
400D 400EA/55 400TD 400ET/70		XD3 XD3T	2500	4	095-0204A	36,60	31,90	4,3	12,5	1
					095-0204B	37,00	31,90	4,5		









C P R

Übermass-Vorkammern

Modell	Abbildung	Motor Code	Hubraum cm ³	Anzahl Zylinder	CPR Art. Nr.	D ∅ mm	d ∅ mm	H mm	Einspritz Öffnung mm	Typ
Fiat										
Scudo D/TD Ducato TD		XUD9 XUD9TE	1900	4	095-0104A	32,15	28,10	4,2	11,5	1
					095-0104B	32,65	28,10	4,5		
Ulisse		XUD11 BTE	2100	4	095-0205C	34,10	29,80	4,2	12	1
					095-0205D	34,50	29,80	4,5		
Ducato			2500	4	095-0203C	36,20	30,30	4,8	12	1
					095-0203D	36,70	30,30	5,0		
Ducato			2800	4	095-1103A	38,80	32,60	5,7	14,5	1
					095-1103B	39,00	33,10	6,0		
Ford										
Escort Fiesta Orion		LTA LTB LTC	1600	4	095-0803E	30,60	26,50	4,3	11,5	1
					095-0803F	31,10	26,50	4,5		
Fiesta D Escort D Orion D Courier D Mondeo D Sierra D		RTC RTA RFM	1800	4	095-0104C	31,40	27,50	5,2	11,5	1
					095-0104D	31,80	27,50	5,5		
Econovan Courier Escort Tempo		RF	2000	4	095-0601A	35,15	30,00	5,8	13	1
					095-0601B	35,50	30,00	6,2		
Sierra D Sierra LD Sierra GLD		XD2	2300	4	095-0205E	35,15	28,80	4,3	12	1
					095-0205F	35,50	28,80	4,5		
Bronco II TD Ranger 2WD Ranger 4WD		4D55T	2300	4	095-0901A	34,10		24,8	19	1
					095-0901B	34,60		25,2		

C P R

Übermass-Vorkammern

Modell	Abbildung	Motor Code	Hubraum cm ³	Anzahl Zylinder	CPR Art. Nr.	D ∅ mm	d ∅ mm	H mm	Einspritz Öffnung mm	Typ
Granada D Scorpio D Scorpio LD		XD3	2500	4	095-0204A	36,60	31,90	4,3	12,5	1
					095-0204B	37,00	31,90	4,5		
Scorpio D Granada D		VM25 T VM923 B	2400	4	095-0205G	35,60	30,40	4,8	12	1
					095-0205H	36,00	30,40	5,0		
Hyundai										
Lantra		XUD9A/L	1900	4	095-0104A	32,15	28,10	4,2	11,5	1
					095-0104B	32,65	28,10	4,5		
Hyundai H100 Hyundai H1		4D56 D4BA	2500	4	095-0902A	34,10		25,0	17	3
					095-0902B	34,60		25,2		
Hyundai H100 Hyundai H1 D/TD		4D56/ D4BA 4D56T/ D4BA 4D55	2500	4	095-0901A	34,10	24,8	3,0	19	
			2300		095-0901B	34,60	25,2	3,0		
Isuzu										
Gemini I-Mark		4EC1	1500	4	095-0803A	30,10	25,40	4,3	11,5	1
					095-0803B	30,50	25,40	4,6		
Gemini TD I-Mark TD		T4EC1	1500	4	095-0801A	30,10	25,50	4,3	13,5	1
					095-0801B	30,50	25,50	4,6		
Iveco										
Ducato			2500	4	095-0203C	36,20	30,30	4,8	12	1
					095-0203D	36,70	30,30	5,0		









C P R

Übermass-Vorkammern

Modell	Abbildung	Motor Code	Hubraum cm ³	Anzahl Zylinder	CPR Art. Nr.	D ∅ mm	d ∅ mm	H mm	Einspritz Öffnung mm	Typ
Iveco										
Ducato Daily New Daily			2800	4	095-1103A	38,80	32,60	5,7	14,5	1
					095-1103B	39,00	33,10	6,0		
Jeep										
Cherokee D/TD		J8S Turbo	2100	4	095-1202A	35,65	30,00	4,5	13	1
					095-1202B	36,10	30,00	4,8		
Grand Cherokee D/TD		VM25T VM	2400	4	095-0205G	35,60	30,40	4,8	12	1
					095-0205H	36,00	30,40	5,0		
KIA										
Esportage TD		RF	2000	4	095-0601A	35,15	30,00	5,8	13	1
					095-0601B	35,50	30,00	6,2		
Besta		R2	2200	4	095-0601C	36,10	31,00	5,8	13	1
					095-0601D	36,50	31,00	6,2		
K 2500		J2	2500	4	095-0903C	34,10	30,00	13,4	18	3
					095-0903D	34,50	30,00	13,9		
K 2700			2700	4	095-1102A	39,10	31,60	5,7	13,5	3
					095-1102B	39,60	31,60	6,2		





C P R

Übermass-Vorkammern

Modell	Abbildung	Motor Code	Hubraum cm ³	Anzahl Zylinder	CPR Art. Nr.	D ∅ mm	d ∅ mm	H mm	Einspritz Öffnung mm	Typ
Lancia										
Zeta 12V		XUD11BT E (P8C)	2100	4	095-0205C	34,10	29,80	4,2	12	1
					095-0205D	34,50	29,80	4,5		
Land Rover										
Range Rover		M51	2500	6	095-0802A	31,00	27,50	4,3	11	1
					095-0802B	31,50	27,50	4,6		
Mazda										
323		4EE1-T	1700	4	095-0701A	33,10	26,70	4,3	13,8	1
					095-0701B	33,50	26,70	4,6		
626		RF	2000	4	095-0601A	35,15	30,00	5,8	13	1
					095-0601B	35,50	30,00	6,2		
E2200		R2	2200	4	095-0601C	36,10	31,00	5,8	13	1
					095-0601D	36,50	31,00	6,2		
626 RF7		RF-CX Complex	2000	4	095-0602A	36,10	31,00	5,8	13	1
					095-0602B	36,50	31,00	6,2		
626		R2	2000	4	095-0502A	35,60	31,00	5,8	13,7	2
					095-0502B	36,10	31,00	6,2		
Mitsubishi										
Carisma		F8Q	1900	4	095-0302A	37,60	32	4,6	11,5	1
					095-0302B	38,10	32	4,8		



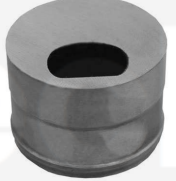





C P R

Übermass-Vorkammern

Modell	Abbildung	Motor Code	Hubraum cm ³	Anzahl Zylinder	CPR Art. Nr.	D ∅ mm	d ∅ mm	H mm	Einspritz Öffnung mm	Typ
Mitsubishi										
Space Wagon Colt/Lancer Galant		4D65	1800	4	095-1001A	31,10		21,8	15	
					095-1001B	31,60		22,2		
Lancer Galant Space Runner Space Wagon		4D68	2000	4	095-1002A	31,10		21,8	14,8	
					095-1002B	31,60		22,2		
Montero Pajero D/TD L 300 Canter Galant		4D56 4D55	2500 2300	4	095-0901A	34,10		25,0	19	
					095-0901B	34,60		25,2		
Montero Pajero TD L 300 Canter		4D56	2500	4	095-0902A	34,10		25,0	17	3
					095-0902B	34,60		25,2		
Pajero TD/D Shogun TD Canter T/TD		4M40 4M40T	2800	4	095-0903A	34,00		13,4	18	
					095-0903B	34,50		13,9		
Nissan										
Terrano		TD 27	2700	4	095-TD27A	37,10	33,8	6,4	16	1







C P R

Übermass-Vorkammern

Modell	Abbildung	Motor Code	Hubraum cm ³	Anzahl Zylinder	CPR Art. Nr.	D ∅ mm	d ∅ mm	H mm	Einspritz Öffnung mm	Typ
Opel										
Astra D/TD Vectra D Kadet D		17YD X17DTD 17D/DR	1700	4	095-0104E	32,00	26,70	4,2	11,5	1
					095-0104F	32,50	26,70	4,5		
Belmont D Cavalier Kadet ED Ascona C		16D 16DA	1600	4	095-0104E	32,00	26,70	4,2	11,5	1
					095-0104F	32,50	26,70	4,5		
Omega Record		23D/TD 23YD	2300	4	095-0301A	34,10	29,80	4,2	12	1
					095-0301B	34,50	29,80	4,5		
Corsa D Astra D Vectra TD Kadet Combo		TC4EE1 X17DT	1700	4	095-0701A	33,10	26,7	4,3	13,8	1
					095-0701B	33,50	26,7	4,6		
					095-0701C	35,10	28,7	4,3	13,8	1
					095-0701D	35,50	28,7	4,6		
Astra Corsa Combo		4EE1	1700	4	095-0702A	33,10	26,7	4,3	11,5	1
					095-0702B	33,50	26,7	4,6		
Corsa D Nova		4EC1	1500	4	095-0702C	35,10	28,7	4,3	11,5	1
					095-0702D	35,50	28,7	4,6		
Corsa - Nova Corsa B Kadet E		T4EC1	1500	4	095-0801A	30,10	25,50	4,3	13,5	1
					095-0801B	30,50	25,50	4,6		
Corsa B		4EC1	1500	4	095-0803A	30,10	25,40	4,3	11,5	1
					095-0803B	30,50	25,40	4,6		
Frontera D/TD		VM	2400	4	095-0205G	35,60	30,40	4,8	12	1
					095-0205H	36,00	30,40	5,0		







C P R

Übermass-Vorkammern

Modell	Abbildung	Motor Code	Hubraum cm ³	Anzahl Zylinder	CPR Art. Nr.	D ∅ mm	d ∅ mm	H mm	Einspritz Öffnung mm	Typ
Opel										
Omega TD		M51	2500	6	095-0802A	31,00	27,50	4,3	11	1
					095-0802B	31,50	27,50	4,6		
Perkins										
		4.108 4.99	1760 1620	4	095-1301A	31,85		9,7	11	2
					095-1301B	32,30		10		
Idem		4.108 4.99 4.154	1760 1620 2520	4	095-1302A	31,85		9,7	14	2
					095-1302B	32,30		10		
		4.165 4.154	2710 2520	4	095-1303A	34,85		10,8	15	2
					095-1303B	35,30		11,5		
		100.104. 19	1900	4	095-0401C	32,10	27,40	4,3	12	1
					095-0401D	32,50	27,40	4,6		
Barreiros			2500	4	095-1304A	31,90		9,9	13	1
					095-1304B	32,30		10,3		
		104.22			095-0503A	34,80	29,7	4,1	14	1









C P R

Übermass-Vorkammern

Modell	Abbildung	Motor Code	Hubraum cm ³	Anzahl Zylinder	CPR Art. Nr.	D ∅ mm	d ∅ mm	H mm	Einspritz Öffnung mm	Typ
Peugeot										
305GLD/SRD 309GLD/SRD 309XLD/XRD 309GRD/D 205D 405GLD 405D/TD 306D/TD 806D/TD Boxer		XUD9 XUD9A XUD9A/ L XUD9TE	1900	4	095-0104A 095-0104B	32,15 32,65	28,10 28,10	4,3 4,5	11,5	1
J5D		U/25/ 651	2500	4	095-0203A 095-0203B	36,50 37,00	29,80 29,80	5,0 5,3	12	2
505D 505GRD 505SRD J7D J9D		XD2	2300	4	095-0205E 095-0205F	35,15 35,50	28,80 28,80	4,3 4,5	12	1
505GRD 505SRD J9D 505GTD 505TDE 606GTD		XD3 XD3T XD3TE	2500	4	095-0204A 095-0204B	36,60 37,00	31,90 31,90	4,3 4,5	12,5	1
Boxer		DJ5T	2500	4	095-0201A 095-0201B	36,70 37,00	31,70 31,70	4,2 4,5	18	1
Boxer		DJ5/T9A	2500	4	095-0202A 095-0202B	36,70 37,00	31,70 31,70	4,2 4,5	14	1
605 406 806		XUD11	2100	4	095-0205C 095-0205D	34,10 34,50	29,80 29,80	4,2 4,5	12	1







C P R

Übermass-Vorkammern

Modell	Abbildung	Motor Code	Hubraum cm ³	Anzahl Zylinder	CPR Art. Nr.	D ∅ mm	d ∅ mm	H mm	Einspritz Öffnung mm	Typ
Pegaso										
Ekus D/TD		DW DV	2400	6	095-0101A	32,10	27,40	4,3	11,5	1
					095-0101B	32,20	27,40	4,4		
					095-0101C	32,50	27,40	4,6		
Rover										
218 SD 418 SLD		XUD9A XUD9	1900	4	095-0104A	32,15	28,10	4,3	11,5	1
					095-0104B	32,65	28,10	4,5		
Range Rover 2500 TD 2400 TD		VM	2500 2400	4	095-0205G	35,60	30,40	4,8	12	1
					095-0205H	36,00	30,40	5,0		
Renault										
Espace Megane Laguna		G8T	2200	4	095-0204C	36,70	29,70	4,5	12,5	1
					095-0204D	37,20	29,70	5,0		
R19D R5D/VAN Megane 1,9D Clio 1,9D Kangoo		F8Q	1900	4	095-0302A	37,60	32,00	4,6	11,5	1
					095-0302B	38,10	32,00	4,8		
R19TD CHAMADE Megane-Scenic Kangoo		F8Q Turbo	1900	4	095-0303A	37,60	32,00	4,6	12	1
					095-0303B	38,10	32,00	4,8		
Espace R18D Laguna R21D R21D Nevada Trafic R25D Safrane		J8S	2100	4	095-1201A	35,65	30,00	4,5	11,5	1
					095-1201B	36,10	30,00	4,8		
Espace, R18TD Laguna R21TD Nevada R21TD, R25TD Safrane		J8S Turbo	2100	4	095-1202A	35,65	30,00	4,5	13	1
					095-1202B	36,10	30,00	4,8		
Seat										
Toledo D Ibiza D Toledo TD Ibiza TD		1Y AAZ	1900	4	095-0102A	32,10	27,90	4,3	12,5	1
					095-0102B	32,20	27,90	4,4		
					095-0102C	32,50	27,90	4,6		

C P R

Übermass-Vorkammern

Modell	Abbildung	Motor Code	Hubraum cm ³	Anzahl Zylinder	CPR Art. Nr.	D ∅ mm	d ∅ mm	H mm	Einspritz Öffnung mm	Typ
Skoda										
Octavia D/TD Fabia D/TD			1900	4	095-0102A 095-0102B 095-0102C	32,10 32,20 32,50	27,90 27,90 27,90	4,3 4,4 4,6	12,5	1
Ssang Yong										
Korando Family		XD3	2500	4	095-0204A 095-0204B	36,60 37,00	31,90 31,90	4,3 4,5	12,5	1
Suzuki										
Vitara D/TD		XUD9	1900	4	095-0104A 095-0104B	32,15 32,65	28,10 28,10	4,2 4,5	11,5	1
Vitara		R2	2200	4	095-0601C 095-0601D	36,10 36,50	31,00 31,00	5,8 6,2	13	1
Talbot										
Horizon		XUD9	1900	4	095-0104A 095-0104B	32,15 32,65	28,10 28,10	4,3 4,5	11,5	1
Tagora TD		XD2S	2300	4	095-0205E 095-0205F	35,15 35,50	28,80 28,80	4,3 4,5	12	1









C P R

Übermass-Vorkammern

Modell	Abbildung	Motor Code	Hubraum cm ³	Anzahl Zylinder	CPR Art. Nr.	D ∅ mm	d ∅ mm	H mm	Einspritz Öffnung mm	Typ
Toyota										
Carina Corolla Lite-Ace Camry		1C	1800	4	095-0401A	31,65	27,40	5,0	12	3
					095-0401B	32,20	27,40	5,5		
Carina		2C	2000	4	095-0402A	31,60	27,40	5,3	12,5	3
					095-0402B	32,10	27,40	5,5		
Carina		2C-T	2000	4	095-0403A	31,60	27,40	5,3	14	3
					095-0403B	32,10	27,40	5,5		
Hi-Ace Hi-Lux Landcruiser		2LT	2446	4	095-0501A	36,70	33,80	6,2	16	3
					095-0501B	37,20	33,80	6,5		
PickUp Turbo		2LT-NT	2446	4	095-0501C	36,70	33,50	6,2	16	3
					095-0501D	37,20	33,50	6,5		
2500 D/TD		VM	2500	4	095-0205G	35,60	30,40	4,8	12	1
					095-0205H	36,00	30,40	5,0		
Land Cruiser TD 4 Runner TD		1KZ-TE	3000	4	095-1101A	38,80	34,10	6,2	16,5	3
					095-1101B	39,00	34,60	6,6		









C P R

Übermass-Vorkammern

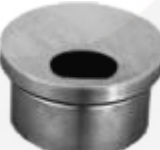
Modell	Abbildung	Motor Code	Hubraum cm ³	Anzahl Zylinder	CPR Art. Nr.	D ∅ mm	d ∅ mm	H mm	Einspritz Öffnung mm	Typ
Vauxhall										
Frontera		VM	2400	4	095-0205G	35,60	30,40	4,8	12	1
					095-0205H	36,00	30,40	5,0		
Corsa D		4EC1	1500	4	095-0803A	30,10	25,40	4,3	11,5	1
					095-0803B	30,50	25,40	4,6		
Corsa TD		T4EC1	1500	4	095-0801A	30,10	25,50	4,3	13,5	1
					095-0801B	30,50	25,50	4,6		
Astra D Belmont D Cavalier D Kadett E D Ascona C		16D 16DA	1600	4	095-0104E	32,00	26,70	4,2	11,5	1
					095-0104F	32,50	26,70	4,5		
Ascona D Vectra D Kadett D		17YD	1700	4	095-0104E	32,00	26,70	4,2	11,5	1
					095-0104F	32,50	26,70	4,5		
Combo D Corsa D		X17D 4EE1	1700	4	095-0702A	33,10	26,7	4,3	11,5	1
					095-0702B	33,50	26,7	4,6		
Astra TD Vectra TD		X17TD TC4EE1	1700	4	095-0701A	33,10	26,7	4,3	13,8	1
					095-0701B	33,50	26,7	4,6		
Omega TD		M51D	2500	6	095-0802A	31,00	27,50	4,3	11	1
					095-0802B	31,50	27,50	4,6		

C P R

Übermass-Vorkammern

Modell	Abbildung	Motor Code	Hubraum cm ³	Anzahl Zylinder	CPR Art. Nr.	D ∅ mm	d ∅ mm	H mm	Einspritz Öffnung mm	Typ
Volkswagen										
Golf D/TD Pasar D/TD Jetta D/TD TransporterD/TD Caddy D/TD Santana D/TD Rabbit D/TD		JK/CY JP/JR CR/JX	1600	4	095-0101A	32,10	27,40	4,3	11,5	1
					095-0101B	32,20	27,40	4,4		
					095-0101C	32,50	27,40	4,6		
Transporter Caravelle		KY	1700	4	095-0101A	32,10	27,40	4,3	11,5	1
					095-0101B	32,20	27,40	4,4		
					095-0101C	32,50	27,40	4,6		
Golf D/TD Sharan TD Passat TD Vento D/TD Variant TD TransporterD/TD		1Y AAZ ABL 1X AFE AEY	1900	4	095-0102A	32,10	27,90	4,3	12,5	1
					095-0102B	32,20	27,90	4,4		
					095-0102C	32,50	27,90	4,6		
LT D/TD		DV DW CP 1G 1S ACT	2400	6	095-0101A	32,10	27,40	4,3	11,5	1
					095-0101B	32,20	27,40	4,4		
					095-0101C	32,50	27,40	4,6		
Transporter T4		AAB AJA	2400	5	095-0101D	32,10	27,90	4,3	11,5	1
					095-0101E	32,20	27,90	4,4		
					095-0101F	32,50	27,90	4,6		
Polo 1,3 D Golf D/TD Golf, Passat		MN ME, MF, SB CK	1300 1600 1500	4	095-0803C	30,10	25,40	4,3	11,5	1
					095-0803D	30,50	25,40	4,6		
Volvo										
240 D+TD 740 D+TD 760 D+TD 940 GLE 969 TD		D24 D24T	2400	6	095-0101A	32,10	27,40	4,3	11,5	1
					095-0101B	32,20	27,40	4,4		
					095-0101C	32,50	27,40	4,6		
460 TD 440 TD S40 V40		D19T D4192	1900	4	095-0302A	37,60	32	4,6	11,5	1
					095-0302B	38,10	32	4,8		

Übermass – Vorkammern

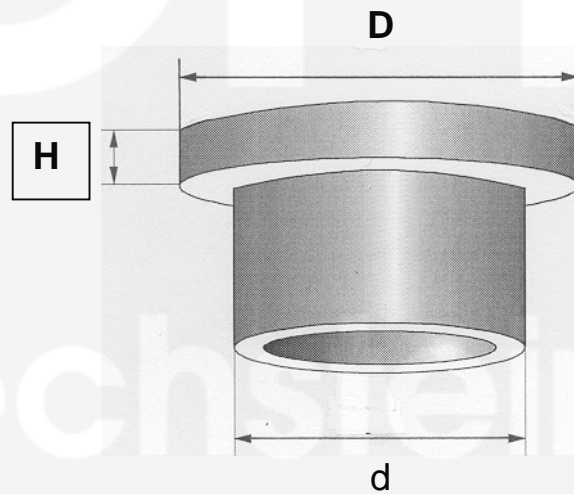

Ausführungen:

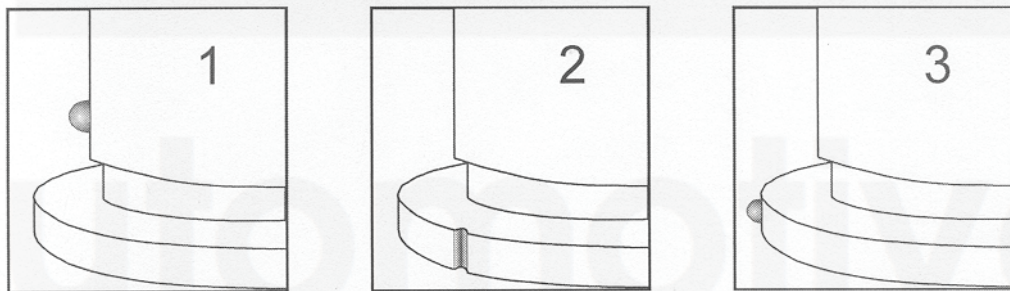

Tel. 0800 751 9 751
Fax 07742 2917
shop@cpr-automotive.de

CPR
Rechsteiner

CPR (Deutschland) Auslieferung
Industriestrasse 4
D-79801 Hohentengen
www.cpr-automotive.de

Gewinderinge / Werkzeuge für MERCEDES Vorkammern

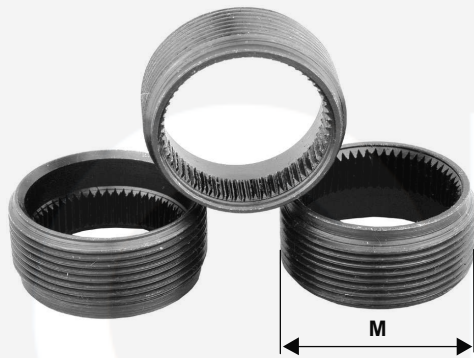

€ 12.80 zzgl. MwSt

M35x1.5	CPR Art. Nr. 095-MS20-M35
M36x1.5	CPR Art. Nr. 095-MS20-M36
M37x1.5	CPR Art. Nr. 095-MS20-M37

Gewinderinge / Übermass-Gewinderinge

Mercedes Ref. Nr. A6010170203



Netto € **78.00** zzgl. MwSt

CPR Art. Nr. 095-MS10

Montage-Werkzeug für Gewinderinge



Netto € **124.00** zzgl. MwSt pro Artikel

Gewindeschneider mit Führung

M35x1.5	CPR Art. Nr. 095-MS30B-M35 Fertigschneider
M36x1.5	CPR Art. Nr. 095-MS30A-M36 Vorschneider
M36x1.5	CPR Art. Nr. 095-MS30B-M36 Fertigschneider
M37x1.5	CPR Art. Nr. 095-MS30A-M37 Vorschneider
M37x1.5	CPR Art. Nr. 095-MS30B-M37 Fertigschneider



Kernlochfräser mit Führung

d = 35.4 mm CPR Art. Nr. 095-MS40-M37 Kernlochfräser
Netto € **168.00** zzgl. MwSt mit Führung

Tel. 0800 751 9 751

Fax 07742 2917

shop@cpr-automotive.de

CPR
Rechsteiner

CPR (Deutschland) Auslieferung
Industriestrasse 4
D-79801 Hohentengen
www.cpr-automotive.de